

**pui  
audio**™ inc  
a projects unlimited company

## AI-3245-TF-LW95-R 32mm Indicator

3541 Stop Eight Road • Dayton, Ohio 45414

### Product Overview

- 32mm diameter, 3-28 VDC self-drive indicator
- 90 dBA minimum output (12 VDC @ 10 cm) and 4,500 Hz continuous tone
- ABS housing and 95mm long 26 AWG UL1007 lead wires
- Built-on mounting tabs for quick, easy mounting

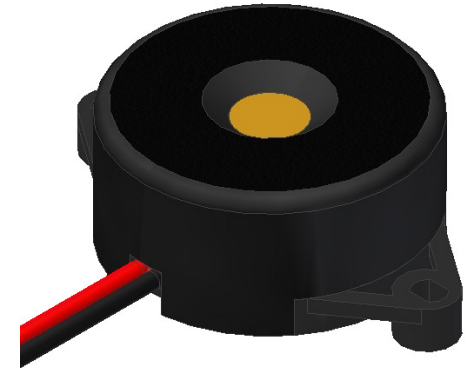

**SPL vs Voltage (measured @ 30 cm)**

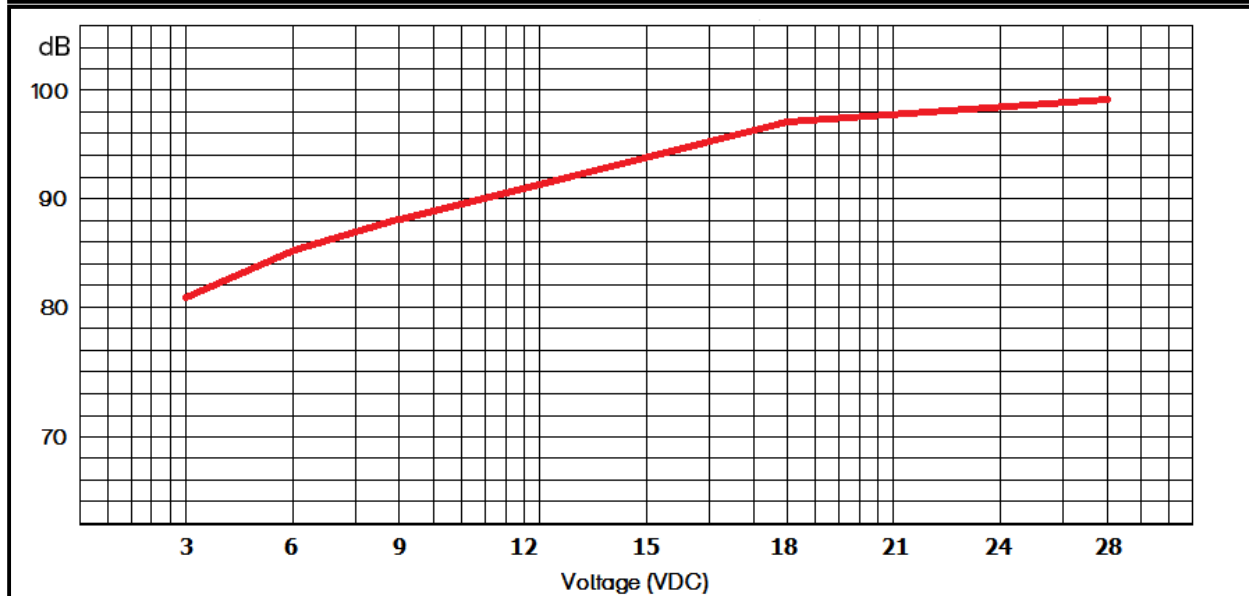

RoHS Compliant



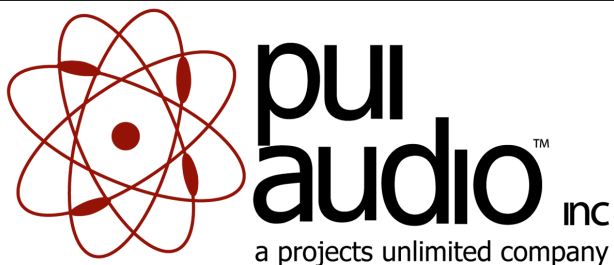

# AI-3245-TF-LW95-R

## 32mm Indicator

Mechanical and Environment Testing	
Test Description	Test Condition
High Temperature	+70°C (±2°C) with random humidity for 96 hours
Low Temperature	-30°C (±2°C) with random humidity for 96 hours
Humidity	40°C (±2°C) with 90% to 95% relative humidity for 96 hours
Vibration	1.5 mm movement modulated at 10-55 Hz for two hours in three directions
Drop Test	75 cm free fall onto wood board, 9 cycles
Temperature Cycle Test	-40°C to 95°C, five 3 hour cycles

After tests, part shall rest for 2 hours. Parts are then tested for clean, pure tones.

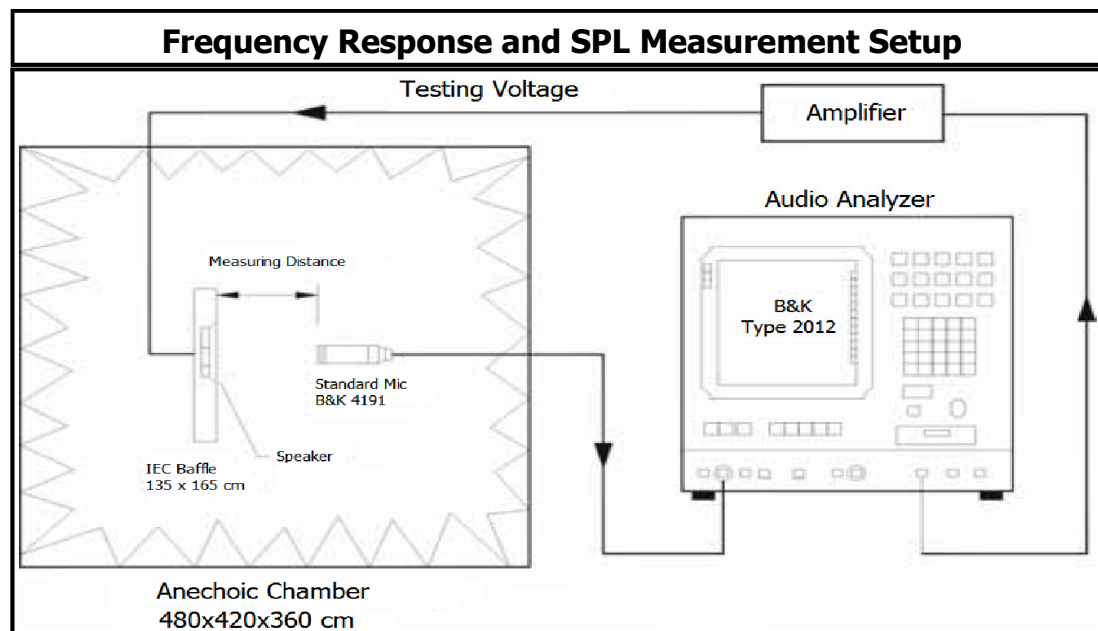

# SPECIFICATIONS

PARAMETERS	VALUES	UNITS
RATED VOLTAGE	12	Vdc
OPERATING VOLTAGE RANGE	3 ~ 28	Vdc
RATED CURRENT (MAX)	5	mA
MINIMUM SPL @ 10 CM	90	dBA
RESONANT FREQUENCY	4,500 ± 500	Hz
tone OR PULSE RATE	CONTINUOUS	0 pulse /sec
OPERATING TEMPERATURE	-20 ~ +60	°C
STORAGE TEMPERATURE	-30 ~ +70	°C
HOUSING MATERIAL	ABS	-
TERMINAL MATERIAL	LEAD WIRE	-
WEIGHT	5	grams

THIS DOCUMENT CONTAINS DATA PROPRIETARY TO PROJECTS UNLIMITED, INC. ANY USE OR REPRODUCTION, IN ANY FORM, WITHOUT PRIOR WRITTEN PERMISSION OF PROJECTS UNLIMITED, INC. IS PROHIBITED.  
©2003, Projects Unlimited Inc.

## REVISION HISTORY

LTR	DESCRIPTION	DATE	APPROVED
-	RELEASED FROM ENGINEERING	8/19/2004	
A	REMOVED LEAD FREE ADDED RoHS NOTE	8/10/2005	
B	REVISED TO INVENTOR 3-D DRAWING TEMPLATE & HEIGHT/SOUND HOLE DIMENSIONS	3/12/2008	B.R.

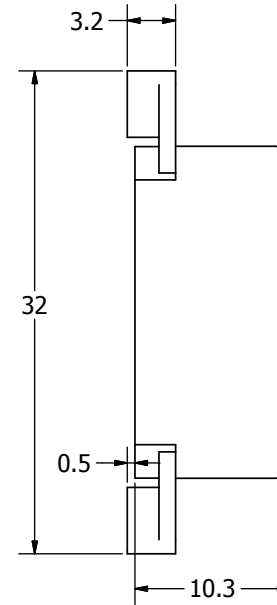
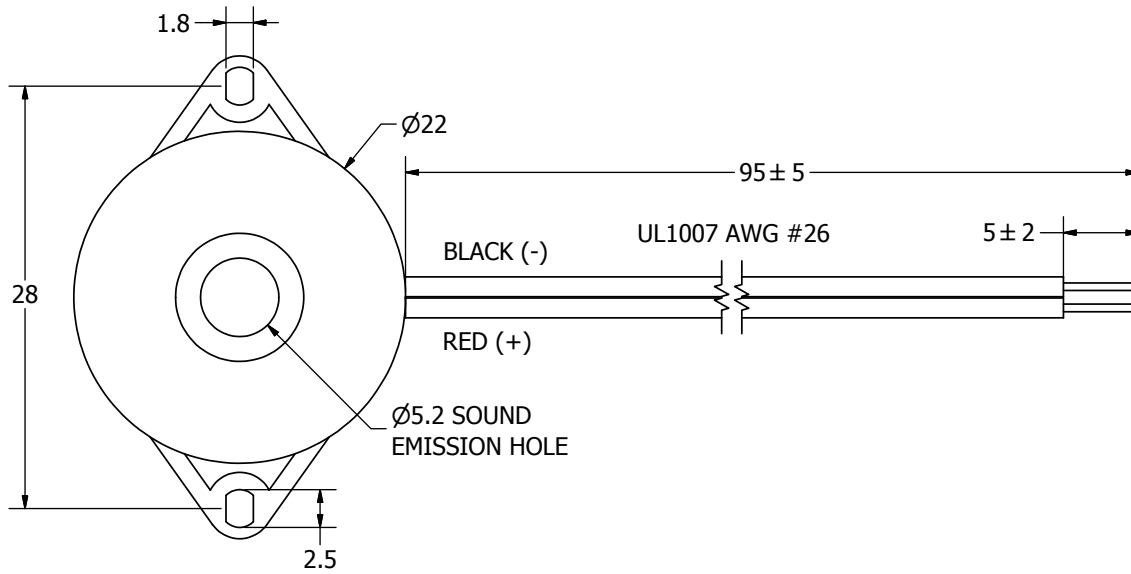

### NOTES:

1. ALL DIMENSIONS ARE IN MILLIMETERS.
2. SPECIFICATIONS SUBJECT TO CHANGE OR WITHDRAWAL WITHOUT NOTICE.
3. THIS PART IS RoHS 2002/95/EC COMPLIANT.

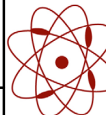
UNLESS OTHERWISE SPECIFIED: DIMENSIONS ARE IN MILLIMETERS, TOLERANCES ARE ±0.5 AND ANGLES ARE ±3°.	SIZE	Designed by	Date	Checked by	Date	Approved by	Date	Drawn Date	
	A3	R.A.C.	8/19/2004			R.W.	8/19/2004	3/12/2008	
AI-3245-TF-LW95-R.idw	 <b>pui audio</b> a projects unlimited company	<b>AI-3245-TF-LW95-R</b>					Indicator	Edition	Sheet
							-	1 / 1	